

# 193339 Oil Pump IMV Valve Technical File

SKU: G1H90000193339

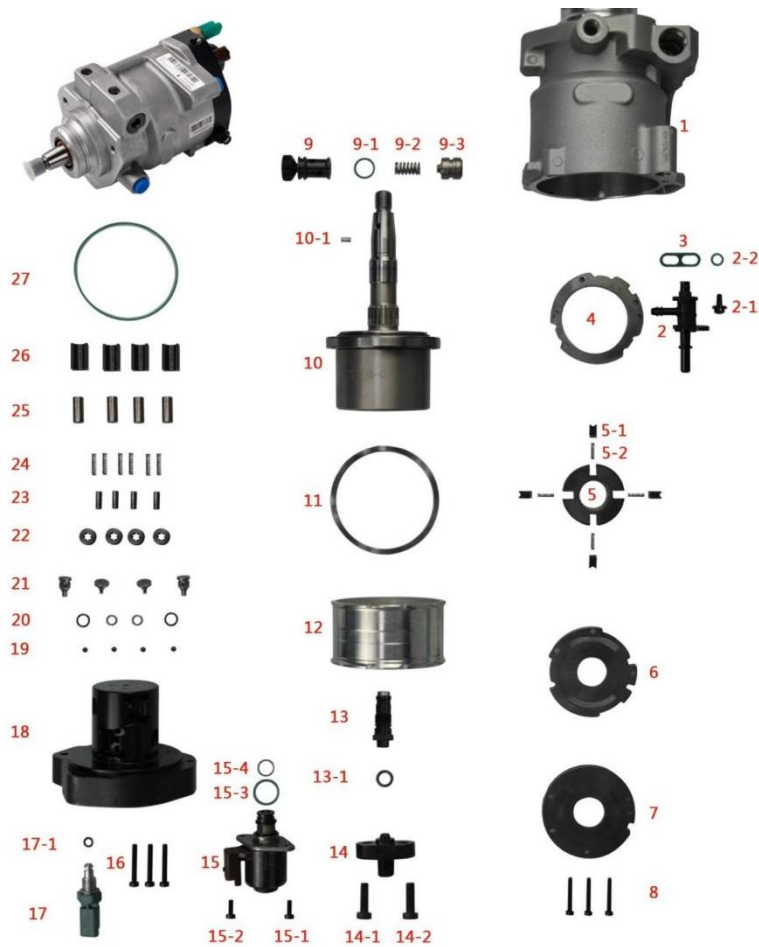

## 193339 Oil Pump IMV Valve Technical File

### Content

1. 193339 Oil Pump IMV Valve Introduction .....	3
1.1. 193339 Oil Pump IMV Valve Basic Information .....	3
1.2. 193339 Oil Pump IMV Valve Applicable Oil Pump Information .....	3
1.3. 193339 Oil Pump IMV Valve Specifications And Dimensions .....	3
1.4. 193339 Oil Pump IMV Valve Quality Control .....	3
1.5. 193339 Oil Pump IMV Valve Customization Service .....	3
1.6. 193339 Oil Pump IMV Valve Packaging List .....	4
1.7. 193339 Oil Pump IMV Valve Warranty Instructions .....	5
1.8. 193339 Oil Pump IMV Valve Manufacturer .....	6
2. 193339 Oil Pump IMV Valve Technical Support .....	6
2.1. 193339 Oil Pump IMV Valve Technical Support Obtaining Methods .....	6
3. 193339 Oil Pump IMV Valve Purchase And Delivery .....	6
3.1. 193339 Oil Pump IMV Valve Purchase And Payment Term .....	6
3.2. 193339 Oil Pump IMV Valve Main Sales Markets .....	6
3.3. 193339 Oil Pump IMV Valve Declaration Requirements .....	6
3.4. 193339 Oil Pump IMV Valve Shipping Ways .....	6
3.5. 193339 Oil Pump IMV Valve Delivery Time .....	6
3.6. 193339 Oil Pump IMV Valve Logistics Time for Destination Out of China's Areas .....	6
3.7. 193339 Oil Pump IMV Valve Shipping Package .....	7
4. 193339 Oil Pump IMV Valve Storage Standards .....	8
5. Company Information .....	9
5.1. Company Introduction .....	9
5.2. Sales Contact Information .....	10
6. Copyright Statement .....	10

## 193339 Oil Pump IMV Valve Technical File

### 1. 193339 Oil Pump IMV Valve Introduction

#### 1.1. 193339 Oil Pump IMV Valve Basic Information

Title	Common Rail Oil Pump IMV Valve 193339	Quality
SKU	G1H90000193339	China Made New

#### 1.2. 193339 Oil Pump IMV Valve Applicable Oil Pump Information

##### (1) 193339 Oil Pump IMV Valve Applicable Car Model

Oil Pump IMV Valve Part Number	Car Model	OE Number	OE Number	OE Number
193339	For Ford	9307Z532A	1933.39	9109-927

##### (2) 193339 Oil Pump IMV Valve Applicable Oil Pump Model

Series	Oil Pump Part Number	OE Number	Car Model	Engine Model
CR	/	/	/	/

##### (3) 193339 Oil Pump IMV Valve Common Writing

193339

#### 1.3. 193339 Oil Pump IMV Valve Specifications And Dimensions

Oil Pump IMV Valve Size: 7cm\*7cm \*7 cm

Oil Pump IMV Valve Packaging Size: 9 cm \*8 cm \*8cm

Single Oil Pump IMV Valve Weight: 0.2kg

Oil Pump IMV Valve Packaging Weight: 0.29kg

Oil Pump IMV Valve Quality: China Made New

Oil Pump IMV Valve MOQ: 1 Piece

#### 1.4. 193339 Oil Pump IMV Valve Quality Control

##### (1) Oil Pump IMV Valve Testing

All parts of the oil pump IMV valve have undergone electrical characteristics testing, precision testing, high temperature testing, low temperature testing, withstand pressure testing, leakage testing, durability testing, and various working conditions testing.

##### (2) Oil Pump IMV Valve Inspection

The factory inspection of the oil pump IMV valve has undergone three inspections: full inspection, random inspection, and batch inspection. Different brands of test benches are used to test the same oil pump IMV valve for a total of no less than three times for factory inspection, and the fuel injector installation testing environment are progressed in dust-free workshop.

#### 1.5. 193339 Oil Pump IMV Valve Customization Service

(1) Oil Pump IMV Valve Customization Service Coverage: Meet OEM manufacturers' customization needs for oil pump IMV valve engraving, oil pump IMV valve packaging and labels, etc.

	
Neutral Engraving	Anti-rust Bag
	
Neutral Label	Neutral Brown Packaging

**(2) Oil Pump IMV Valve Customization Service Requirements:**

The purchase of customized oil pump IMV valve package is no less than 100 pieces.

The purchase of customized oil pump IMV valve engraving is no less than 100 pieces.



The sales of customized oil pump IMV valve is no less than 1000 pieces.

When customized products involve the need for a specified logo, the OEM manufacturer must provide trademark authorization and provide a sample logo image file.

▲ Once the customized oil pump IMV valve is sold, it can't be returned or exchanged if there is no quality problems.

**1.6. 193339 Oil Pump IMV Valve Packaging List**

**(1) Oil Pump IMV Valve Spare Parts List**

NO.	1	2
Picture		
Name	Oil Pump IMV Valve	Anti-Rust Bag
Description	IMV valve model 193339	Protect the IMV valve from rusting

NO.	3	4
-----	---	---

<p><b>Picture</b></p>		
<p><b>Name</b></p>	<p>Included Accessories</p>	<p>IMV Valve Packing Box</p>
<p><b>Description</b></p>	<p>Accessories Included With IMV Valves</p>	<p>Protect the IMV valve from damage</p>

- ⚠ Minors are prohibited from using the oil pump IMV valve assembly, IMV valve accessories, IMV valve packing box, and VCI anti-rust bag to avoid personal injury.
- ⚠ The IMV valve packaging boxes are recyclable accessories and can be reused.
- ⚠ VCI anti-rust bags are non-degradable materials, please dispose of them properly after using.

**1.7. 193339 Oil Pump IMV Valve Warranty Instructions**

**(1) Oil Pump IMV Valve Warranty Conditions And Instructions**

It is necessary to provide pictures, videos, or test reports tested by the oil pump IMV valve inspection equipment as evidence to feed back to the salesman when the oil pump IMV valve is abnormal during use. Abnormal conditions are properly explained such as: 1.Smoke, 2. Engine shake, 3. Difficulty starting the engine, 4. Engine noise, 5. Oil leakage etc.

The above conditions may also be affected by other parts of the oil pump. If it is confirmed to be a product problem after testing by our company, it is within the warranty scope.

**(2) Oil Pump IMV Valve Warranty Coverage**

- ① After customer receives the **193339** oil pump IMV valve within 15 days , if there is a performance failure and the product has no damage on surface, customer can choose to replace it or repair it;
- ② If the **193339** oil pump IMV valve has performance problems during the warranty period (6-12 months), and it is confirmed to be product’s problems after being tested, you can contact our salesmen to replace the same model.
- ③ If the product is confirmed to be non-defective, it will be returned in its original condition.

**(3) Oil Pump IMV Valve Not Warranty Covered**

- ① The warranty period has expired.
- ② Oil pump IMV valve failure caused by high temperature, high pressure, humidity, rain and snow, saline-alkali land, earthquake, and used in abnormal environment.
- ③ Oil pump IMV valve damage caused by man-made reasons (throwing, strong magnetic field magnetization, set fire).
- ④ Oil pump IMV valve failure or oil pump IMV valve damage caused by non-oil pump IMV valve design, technology, manufacturing, quality and other issues.
- ⑤ Oil pump IMV valve failure due to system pressure exceeding system approved pressure.
- ⑥ Oil pump IMV valve failure caused by impurities (water, lead, aluminum powder, iron powder, sulfide) in the system fuel exceeding the standard requirements.
- ⑦ Oil pump IMV valve failure caused by not installing according to the tightening torque specified in the vehicle engine maintenance manual (the tightening torque is too large or too small).
- ⑧ Oil pump IMV valve failure caused by not following the installation angle specified in the vehicle engine maintenance manual.

- ⑨ Oil pump IMV valve failure caused by not following the cleaning requirements specified in the vehicle engine maintenance manual.
- ⑩ Oil pump IMV valve failure caused by failure to replace consumable parts as specified in the vehicle engine maintenance manual.

### 1.8. 193339 Oil Pump IMV Valve Manufacturer

**Oil Pump IMV Valve Manufacturer:** Shenzhen Shumatt Technology Co., Ltd.

## 2. 193339 Oil Pump IMV Valve Technical Support

### 2.1. 193339 Oil Pump IMV Valve Technical Support Obtaining Methods

- (1) Oil Pump IMV Valve Technical Data: visit <http://shumatt.com> to get the technical data.
- (2) Oil Pump IMV Valve Technical Videos:

**Facebook:** Visit <https://www.facebook.com/hison.li> to get the technical videos, constantly follow can get more information.

**YouTube:** [https://www.youtube.com/channel/UCByvYBx7VjV\\_mAfxh\\_Hu-aw](https://www.youtube.com/channel/UCByvYBx7VjV_mAfxh_Hu-aw) to get the technical videos, constantly follow can get more information.

**Shumatt:** Visit <http://shumatt.com> to obtain the technical videos.

- (3) Oil Pump IMV Valve Information Query Software  
TruckBook Parts EPC APP, download and install on Android/Apple App Store , visit <http://shumatt.com> to get the download and installation tutorial
- (4) Search the Oil Pump IMV Valve test data through TruckBook Parts EPC APP.

## 3. 193339 Oil Pump IMV Valve Purchase And Delivery

### 3.1. 193339 Oil Pump IMV Valve Purchase And Payment Term

**Payment Method:** T/T, Paypal, Alipay, WeChat

**▲ Please contact our salesmen for specific payment information.**

### 3.2. 193339 Oil Pump IMV Valve Main Sales Markets

**Oil Pump IMV Valve Main Sales Markets:** Asia, Europe, North America, South America, Africa etc.

### 3.3. 193339 Oil Pump IMV Valve Declaration Requirements

Shumatt can assist customers to provide the following documents for import customs clearance: contract, invoice, packing list, bill of lading, insurance policy, certificate of origin, etc.

### 3.4. 193339 Oil Pump IMV Valve Shipping Ways

**Destination in China areas:** SF Express, Debon Express, the corresponding logistics company can be provided according to customer requirements in special cases.

**Destinations out of China's areas:** DHL, UPS, FedEx, TNT air, ocean or other shipping methods required by customers.

### 3.5. 193339 Oil Pump IMV Valve Delivery Time

**Delivery Time:** Send out within 3 – 7 working days after receiving payment (Except for special products and special cases).

### 3.6. 193339 Oil Pump IMV Valve Logistics Time for Destination Out of China's Areas

**DHL Logistics Time:**

Place Of Departure	Hong Kong	Other Countries Or Regions In Asia	Australia and New Zealand	Europe	America	Other Countries
Mainland of China	7 Days	7 Days	8 Days	8 Days	8-12 Days	7-10 Days

**UPS Logistics Timeliness: Country or region of origin: Mainland China**

Country of Destination	Estimated Arrival Time	Country of Destination	Estimated Arrival Time	Country of Destination	Estimated Arrival Time
Japan	3 Days	Britain	5-7 Days	Egypt	5-7 Days
Turkey	5-7 Days	Singapore	3 Days	Switzerland	5-7 Days
Bahrain	5-7 Days	Latvia	7-10 Days	New Zealand	7-10 Days
Sri Lanka	5-7 Days	Thailand	3 Days	Austria	5-7 Days
Romania	5-7 Days	Vietnam	3-5 Days	Estonia	5-7 Days
Malaysia	3-5 Days	Israel	5-7 Days	Mexico	7-10 Days
France	5-7 Days	USA	5-7 Days	United Arab Emirates	5-7 Days
Italy	5-7 Days	Netherlands	5-7 Days	Bengal	7-10 Days
Lebanon	5-7 Days	Philippines	3-5 Days	Greece	7-10 Days
South Korea	3 Days	Spain	5-7 Days	Myanmar	5-7 Days
Canada	5-7 Days	Germany	5-7 Days	Saudi Arabia	7-10 Days
Portugal	5-7 Days	Australia	5-7 Days	South Africa	7-10 Days
Denmark	5-7 Days	Belgium	5-7 Days	Ukraine	7-10 Days
India	7-10 Days	Qatar	7-10 Days	Poland	5-7 Days
Indonesia	3-5 Days	Morocco	7-10 Days	Pakistan	7-10 Days
Kuwait	7-10 Days	/	/	/	/

▲ The logistics time is for reference only, subjects are according to the actual arrival.

**3.7. 193339 Oil Pump IMV Valve Shipping Package**

**Domestic Express Packaging:** Usually wrapped in waterproof scotch tape, such as picture No.1.

**International Express Packaging:** Wrapped with waterproof yellow tape after wrapping the black protective film, such as picture No. 2.

**Pallet Shipping:** Use fumigation free and recycling trays that meet export requirements, and use white wrapping protective film to wrap and bind with cable ties for the outside, such as picture No. 3, also, the products can be packaged according to customers' requirements.

▲ The packing tray is made of plastic and can be recycled.

▲ Transparent tape, yellow tape, black wrapping protective film, white wrapping protective film are non-degradable materials, please dispose of them properly.

▲ Minors are prohibited from using transparent tape, yellow tape, black wrapping protective film, and white wrapping protective film to avoid personal injury.



Pic No. 1

**Domestic express packaging:**  
Wrapped with Transparent tape

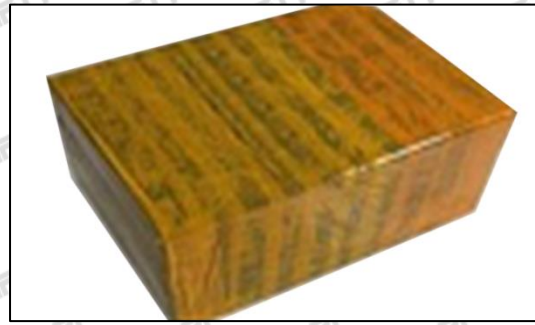

Pic No. 2

**International express packaging:**  
Wrapped with yellow tape after wrapping black protective film



Pic No. 3

**Pallet Shipping:** Use pallet that meet export requirements, and use white wrapping protective film to wrap and bind with cable ties

#### 4. 193339 Oil Pump IMV Valve Storage Standards

##### (1) Choose a Suitable Storage Place

The warehouse and cargo yard where the oil pump IMV valves are stored should be kept clean and dry, and away from the factory buildings that generate harmful gases and dust; do not mix with acid, alkali, salt and other substances; the storage place should have a good drainage system; the cargo yard should be flattened with gravel or furnace ash etc. to enhance the water permeability of the surface layer to keep the reservoir area dry.

##### (2) Strict Storage Requirements

Strict inspections should be carried out when the oil pump IMV valves are put into storage, the surface cleaning work should be done well to remove water traces, oil stains, ash and other dirt, remove the rust and do anti-rust treatment in time. Packaged oil pump IMV valves must be protected from damage.

##### (3) Keep The Warehouse Dry And Do Moisture-proof Work

The relative humidity is usually below 70% for the oil pump IMV valves placed in the room, and the corrosion of the oil pump IMV valves is significantly reduced.

Oil pump IMV valves must be stored in the warehouse, and they are forbidden to store in the same warehouse with commodities with high water content.



## (4) Reasonable Stacking



After the oil pump IMV valve is exposed to rain, the corrosion rate will increase significantly. The purpose of sealing is to isolate the oil pump IMV valve from rainwater and humid air, so the warehouse window should be checked in time to avoid rainwater entering the warehouse.

If the oil pump IMV valve package is damaged, it should be repaired or replaced; when the package is damp, the packaging material should be dried; if the original anti-corrosion and oil applied at the factory is found to be damaged or dried up, it should be cleaned and re-applied oil in time.

- ⚠ It is forbidden to leave the oil pump IMV valve exposed in the air for a long time.
- ⚠ It is forbidden to store acid, alkali, salt and other substances together with the oil pump IMV valve.
- ⚠ The unpacked oil pump IMV valve must be rust-proof during secondary storage.

## 5. Company Information



-  Office Address
-  Global Exhibition

### 5.1. Company Introduction

**Chinese company name:** 深圳市舒马特科技有限公司

**English company name:** Shenzhen Shumatt Technology Co., Ltd.

 **Mobile Phone/WeChat:** +86-13410541523

 **Hong Kong Mobile Phone:** +852-67653519

 **Tel:** +86-755-23215133

 **Email:** ruby@shumatt.com

 **Website:** www.shumatt.com

 **Shenzhen Office:** 11-12, Floor 14, Building 13, Qinchengda Building, Exit A, Honglang North Subway Station, Bao'an District, Shenzhen, China Mainland

 **Shenzhen Office:** Exit C, Qiao Touxu Metro Station, No. 66 Chongqing Road, Fuhai Avenue, Bao'an District, Shenzhen, China Mainland

 **Hong Kong Office:** Jianfa Street Industrial Zone, Tuen Mun, New Territories, Hong Kong, China

 **After-Sales Service Address:** Please contact our salesmen to obtain and provide the corresponding

product maintenance reasons (Reference: [1.7. 193339 Oil Pump IMV Valve Warranty Instructions](#) )

### 5.2. Sales Contact Information

NO.	Name	WeChat/Whatsapp	E-mail
1	Ruby	+86-13410541523	ruby@shumatt.com
2	Ivy	+86-18025309821	sales@shumatt.com
3	Rebecca	+86-18025349821	sales01@shumatt.com
4	Janny	+86-18028749821	sales02@shumatt.com
5	Sam	+86-13316859821	Sales8@shumatt.com
6	Natalie	+86-18938945856	sales15@shumatt.com
7	Ada	+86-1342286353	sales5@shumatt.com
8	Hison Li	+86-18318811871	web@shumatt.com
9	Mecca	+86-18938948618	sales11@shumatt.com
10	Eric	+86 18319033618	sales3@shumatt.com
11	Wayne ( Joaquín en español )	+86-13316959821	wayne@shumatt.com
12	Sylvia	+86 18312499884	sales6@shumatt.com
Visit <a href="http://shumatt.com">http://shumatt.com</a> for the latest sales staff information			
<b>Note: The emails of Shumatt sales staff all end with @shumatt.com</b>			

### 6. Copyright Statement

The copyright of any contents in this file " *193339 Oil Pump IMV Valve Technical File*" (including but not limited to parameters, data, text, charts, images, sounds, videos, etc.) belongs to Shenzhen Shumatt Technology Co., Ltd. Without the prior written permission of Shenzhen Shumatt Technology Co., Ltd., you are not allowed to modify, duplicate, republish any content in " *193339 Oil Pump IMV Valve Technical File*" in any way. At the same time, any conditions to spread, re-post, display the contents of " *193339 Oil Pump IMV Valve Technical File*" should indicate the source of the quoted article, Shenzhen Shumatt Technology Co., Ltd. Any actions failure to follow above conditions violate the "Copyright Law of the People's Republic of China" and other laws and regulations as well as relevant provisions of international conventions.